

KRONOPOL

FERRUM FLOORING

Drewno w dobrej formie



DREWNO W DOBREJ FORMIE
WOOD AT ITS BEST
ДРЕВЕСИНА В СВОЕМ НАИЛУЧШЕМ ОБЛИЧИИ



Kronopol FERRUM FLOORS **Dobrze być razem!**

Dom to przede wszystkim czas, który spędzamy razem. Radosne i wzruszające wspomnienia, magiczne chwile uchwycone na rodzinnych zdjęciach czy pamiątki z szalonych wakacji w gronie najbliższych i przyjaciół. To dzięki nim możemy naprawdę poczuć się u siebie.

Chcemy, aby podłogi Kronopol stały się częścią Twojego domu. Nowa linia podłóg Kronopol FERRUM FLOORS powstała, by uchwycić odrobinę letniej bez troski i pomóc w tworzeniu wnętrz, do których chce się wracać po pracowitym dniu.

**Zapraszamy do poznania oferty
Kronopol FERRUM FLOORS!**

Kronopol FERRUM FLOORS **Good to be together!**

The house is, above all, the time we spend together. Joyful and poignant memories, magical moments captured on family pictures and souvenirs of crazy holidays among family and friends. This is what makes us really feel at home.

We want Kronopol flooring to become part of your home. The new line of flooring, Kronopol FERRUM FLOORS, was created to capture a bit of summer carelessness and help to create the interiors to which we want to come back after a busy day.

**We invite you to learn about the
Kronopol FERRUM FLOORS offer!**

Kronopol FERRUM FLOORS **Хорошо быть вместе!**

Дом – это, прежде всего, время, которое мы проводим вместе.

Радостные и трогательные воспоминания, волшебные мгновения, запечатлённые на семейных фотографиях, и сувениры из безумных поездок в компании близких и друзей. Благодаря всему этому мы можем почувствовать себя как дома.

Мы хотим, чтобы напольные покрытия Kronopol стали частью Вашего дома. Новая линия напольных покрытий Kronopol FERRUM FLOORS была создана для того, чтобы уловить частичку летней беззаботности и помочь создать интерьер, в который хочется вернуться после напряженного дня.

**Приглашаем Вас ознакомиться с
предложением Kronopol FERRUM
FLOORS!**



Kronopol FERRUM FLOORS to nowe spojrzenie na rolę podłóg w domowym wnętrzu. Łącząc innowacyjne rozwiązania technologiczne z dbałością o naturalny i estetyczny wygląd, FERRUM daje niespotykaną dotąd możliwość aranżacji wnętrz dopasowanych do indywidualnych potrzeb i pomysłów.

Nasze panele dostępne są w 5 kolekcjach na płycie 7 lub 8mm i klasie ścieralności AC3 lub AC4. Oferujemy 3 struktury o różnym stopniu połysku oraz głębokości faktury drewna, w sumie 30 niepowtarzalnych w swej barwie i rysunku wzorów.

Panele laminowane są bezpiecznym pokryciem podłogowym, który w ponad 80 % zbudowany jest z lokalnego drewna. W produkcji wykorzystujemy surowiec z lasów gospodarowanych zgodnie z proekologicznymi zasadami FSC. Wzmocniona mineralnie powierzchnia paneli pozwoli cieszyć się Państwu estetyką podłogi przez wiele lat.

Kronopol FERRUM FLOORS is a new view of the role of flooring in home interior. By combining innovative technology solutions with attention to natural and aesthetic appearance, FERRUM provides so far unprecedented opportunity for interior designing tailored to individual needs and ideas.

Our panels are available in five collections, on 7 or 8mm boards and of AC3 or AC4 abrasion class. We offer 3 structures with different degrees of gloss and depth of wood texture, a total of 30 designs, unique in their colour and drawing.

Laminated panels provide a safe floor covering, which in over 80% consists of local timber. For the production, we use raw material from forests managed in accordance with pro-ecological FSC rules.

Mineral-reinforced surface of the panels will allow you to enjoy the aesthetics of flooring for many years.

Kronopol FERRUM FLOORS - это новый взгляд на роль напольных покрытий в домашнем интерьере. Сочетая в себе инновационные технологические решения и натуральный, эстетичный внешний вид, FERRUM предоставляет исключительную возможность создания дизайна интерьера с учетом индивидуальных потребностей и идей.

Наши панели доступны в 5 коллекциях толщиной 7 или 8 мм и степени износостойкости AC3 или AC4. Мы предлагаем 3 структуры с различной степенью блеска и глубиной древесины, в целом 30 уникальных в своих цветах и рисунке декоров.

Ламинированные панели - это безопасное напольное покрытие, в 80 % состоящее из местной древесины. При производстве мы используем сырьё, поступающее из лесов управляемых согласно про-экологическим принципам FSC.

Поверхность панелей, содержащая твердые минералы, позволит Вам наслаждаться эстетикой пола в течении многих лет.



9 /

8
mm







W DOBRYM TOWARZYSTWIE
IN GOOD COMPANY
В ХОРОШЕЙ КОМПАНИИ

Chwile spędzane we wspólnym gronie zastępują na najlepszą oprawę. Świątuj je z kolekcją Sigma, w której specjalna, delikatna struktura drewna szczotkowanego jest dodatkowo podkreślona przez zastosowanie V-Fugi.

Moments spent together deserve the best setting. Celebrate them with Sigma collection, in which a special, delicate brushed wood structure is additionally emphasised by the use of V-groove.

Мгновения, проведённые в дружеской компании, заслуживают самого лучшего оформления. Празднуй их с коллекцией Sigma, в которой специальная текстура потёртой щёткой древесины дополнительно подчеркнута V-образной фаской.

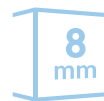

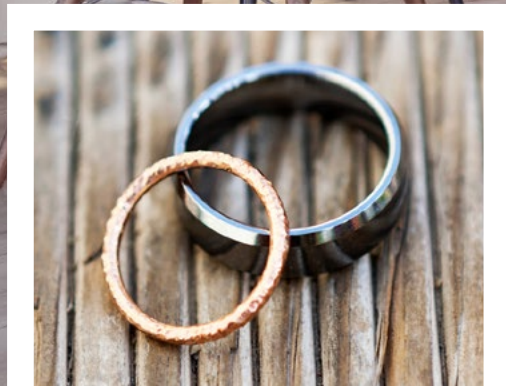



W DOBRYM TOWARZYSTWIE
IN GOOD COMPANY
В ХОРОШЕЙ КОМПАНИИ

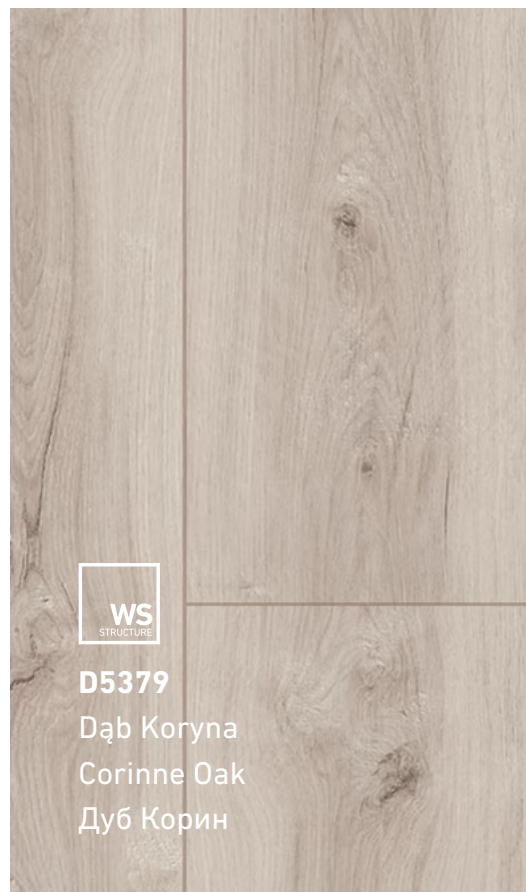

D5379

Dąb Koryna
Corinne Oak
Дуб Корин



D5381

Dąb Ofelia
Ophelia Oak
Дуб Офелия



D5384

Dąb Larysa
Larissa Oak
Дуб Лариса



D5380

Dąb Andromeda
Andromeda Oak
Дуб Андромеда



D5375

Wiąz Kasandra
Kassandra Elm
Вяз Кассандра



D5379

Dąb Koryna
Corinne Oak
Дуб Корин



D5382

Dąb Pamfilia
Pamphylia Oak
Дуб Памфилия

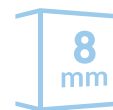

9 panels = 2,397m²

Akcesoria:

idealnie dopasowana listwa MDF-P65

СОКÓŁ P65 / P65 MOULDING / Плинтус P65

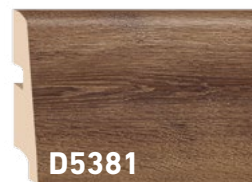

D5381



D5384



D5380

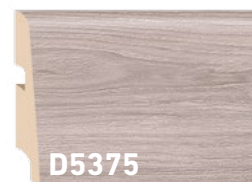

D5375



D5379

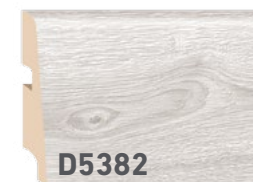

D5382



K

Kappa

PRAWDZIWA PRZYGODA
A REAL ADVENTURE
НАСТОЯЩЕЕ ПРИКЛЮЧЕНИЕ

Pierwszy krok do wielkiej przygody. Postaw go na niezawodnych podłogach z kolekcji Kappa AC4 z głęboką strukturą drewna.

The first step to a great adventure. Take it on a reliable flooring of Kappa AC4 collection, with deep wood structure.

Первый шаг к настоящему приключению. Сделай его на надёжных полах из коллекции Кappa AC4 с глубокой структурой древесины.







PRAWDZIWA PRZYGODA
A REAL ADVENTURE
НАСТОЯЩЕЕ ПРИКЛЮЧЕНИЕ

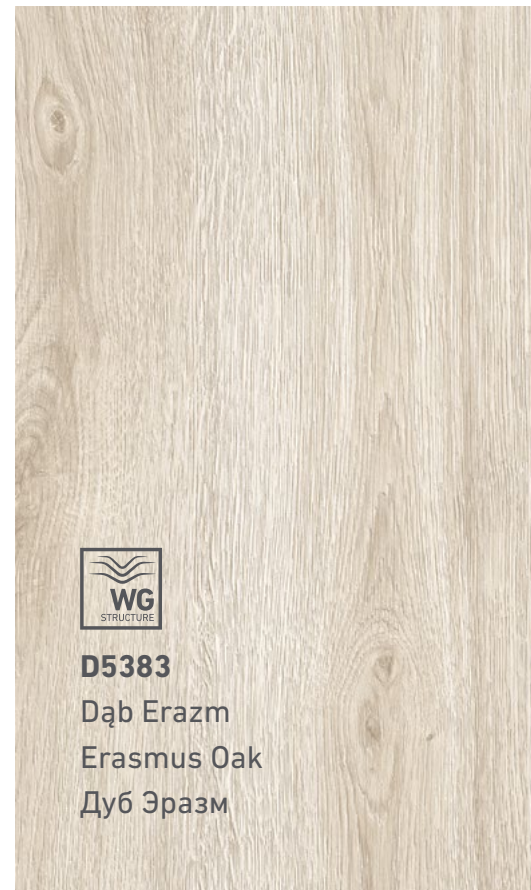

D5383

Dąb Erazm

Erasmus Oak

Дуб Эразм





D5385

Dəb Diogenes
Diogenes Oak
Дуб Диоген



D2598

Dəb Dedal
Daedalus Oak
Дуб Дедал



D2613

Astoria Ikar
Icarus Astoria
Астория Икар



D2596

Dəb Achilles
Achilles Oak
Дуб Ахилл



15
YEARS
WARRANTY

5
PUBLIC
YEARS
WARRANTY



9 panels = 2,397m²

Aksesoria:

idealnie dopasowana listwa MDF-P65

СОКÓŁ P65 / P65 MOULDING / Плинтус P65



D5385



D2598

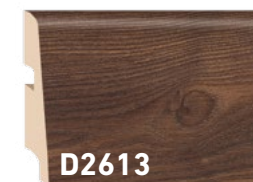

D2613



D2596



D5376



D5383



D5376

Wiąz Hektor
Hector Elm
Вяз Гектор



D5383

Dąb Erazm
Erasmus Oak
Дуб Эразм





RADOŚĆ WSPÓLNYCH CHWIL
THE JOY OF SHARED MOMENTS
РАДОСТЬ СОВМЕСТНЫХ МГНОВЕНИЙ

Egzotyczne miejsca i piękne widoki nabierają prawdziwego smaku, gdy naszymi wrażeniami możemy podzielić się z najbliższymi. Wybierz kolekcję Omega i wspólnie cieszcie się aksamitnym połyskiem nowych podłóg.

Exotic places and beautiful views take on real taste when our impressions can be shared with the loved ones. Choose Omega collection and enjoy together the velvety sheen of new floors.

Экзотические места и живописные пейзажи приобретают реальный вкус, когда мы можем поделиться нашими впечатлениями с самыми близкими. Выберите коллекцию Omega и вместе наслаждайтесь бархатным блеском новых полов.







RADOŚĆ WSPÓLNYCH CHWIL
THE JOY OF SHARED MOMENTS
РАДОСТЬ СОВМЕСТНЫХ МГНОВЕНИЙ



D2060

Dąb Santorini
Santorini Oak
Дуб Санторини



D2023

Dąb Rodos
Rhodes Oak
Дуб Родос



D3837

Pinia Kefalońska
Kefalonia Pine
пиния Кефалония



D2019

Dąb Zakintos
Zakynthos Oak
Дуб Закинтос



D3836

Dąb Mykonos
Mykonos Oak
Дуб Миконос



 9 panels = 2,397m²

Akcesoria:

idealnie dopasowana listwa MDF-P65

СОКÓŁ P65 / P65 MOULDING / Плинтус P65



D2023

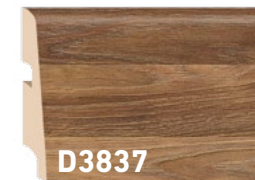

D3837



D2019



D3836



D2060

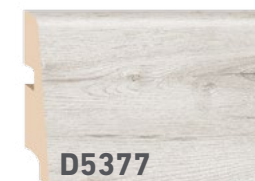

D5377



D2060

Dąb Santorini
Santorini Oak
Дуб Санторини



D5377

Wiąz Korfu
Corfu Elm
Вяз Корфу



Δ

Delta

MIEJSCE Z DUSZĄ
PLACE WITH A SOUL
МЕСТО С ДУШОЙ

Dobrze jest mieć miejsce, do którego można wrócić nawet z najdalszej podróży. Znajdź takie miejsce razem z kolekcją Delta, którą wyróżnia głęboka faktura drewna, nadająca wnętrzą unikalny charakter.

It is good to have a place where you can come back even from the farthest trip. Find such a place with Delta collection, which features deep texture of wood, creating a unique character of the interior.

Хорошо иметь место, куда можно вернуться даже из самого далёкого путешествия. Найдите это место с коллекцией Delta, которая отличается глубокой фактурой древесины, придающей интерьеру уникальный характер







MIEJSCE Z DUSZĄ
PLACE WITH A SOUL
МЕСТО С ДУШОЙ



D5378
Dąb Saloniki
Thessaloniki Oak
Дуб Салоники



D3502

Dəb Olimpia
Olympia Oak
Дуб Олимпия



D5386

Dəb Koryncki
Corinth Oak
Дуб Коринф



D9117

Dəb Patras
Patras Oak
Дуб Патры



D5378

Dəb Saloniki
Thessaloniki Oak
Дуб Салоники



D5387

Dąb Sparta
Sparta Oak
Дуб Спарта



D3461

Pinia Tripoli
Tripoli Pine
Пиния Триполис



10
YEARS
WARRANTY



9 panels = 2,397m²

Akcesoria:

idealnie dopasowana listwa MDF-P65

СОКÓŁ P65 / P65 MOULDING / Плинтус P65

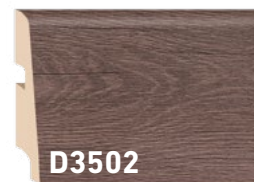

D3502



D5386



D9117



D5378



D5387



D3461



α

Alfa

ODROBINA MAGII NA CO DZIEŃ

A TOUCH OF MAGIC EVERY DAY

ЧАСТИЦА ВОЛШЕБСТВА НА
КАЖДЫЙ ДЕНЬ

Wszędzie dobrze, ale w domu najlepiej.
Uchwyc atmosferę wakacyjnego odpoczynku
i stwórz swój wymarzony dom, dzięki unikal-
nym i trwałym dekorom z kolekcji Alfa.

East or West home is best. Capture the atmosphere of
holiday rest and create your dream home, thanks to
unique and durable décors from the Alpha collection.

Везде хорошо, но дома лучше. Почувствуйте ат-
мосферу отдыха и создайте дом своей мечты с
помощью уникальных и долговечных декоров
из коллекции Alfa.







ODROBINA MAGII NA CO DZIEŃ
A TOUCH OF MAGIC EVERY DAY
ЧАСТИЦА ВОЛШЕБСТВА НА
КАЖДЫЙ ДЕНЬ



D5374

Orzech Metaxa
Metaxa Walnut
Орех Метакса



D2579

Dəb Maraton
Marathon Oak
Дуб Марафон



D5374

Orzech Metaxa
Metaxa Walnut
Орех Метакса



D3511

Dəb Bachus
Bacchus Oak
Дуб Бахус



D3512

Dəb Zorba
Zorba Oak
Дуб Зорба



15
YEARS
WARRANTY

5
PUBLIC
YEARS
WARRANTY



10 panels = 2,663m²

Akcesoria:

idealnie dopasowana listwa MDF-P65

СОКÓŁ P65 / P65 MOULDING / Плинтус P65

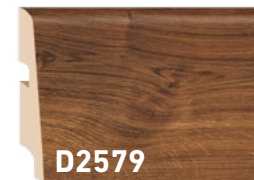

D2579



D5374



D5311



D3512



D2022



D2058



D2022

Jesion Helański

Hellenic Ash

Ясень Эллинистический



D2058

Jesion Ambrozja

Ambrosia Ash

Ясень Амброзия

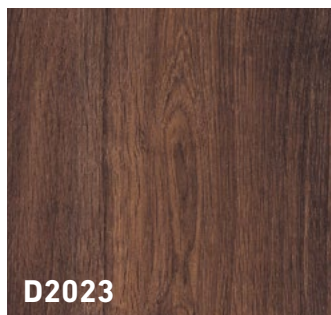

D2023

OMEGA

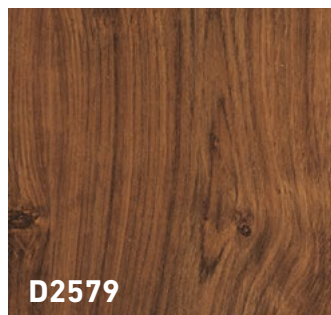

D2579

ALFA

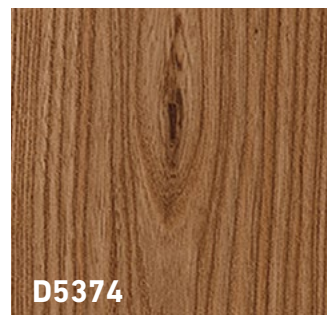

D5374

ALFA



D5378

DELTA



D3511

ALFA

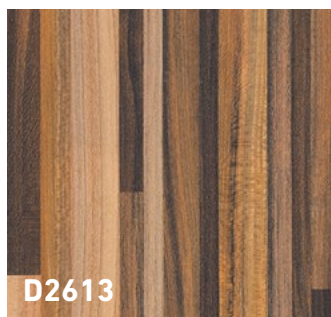

D2613

KAPPA

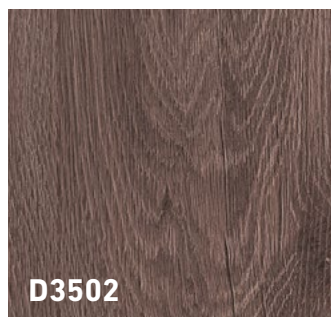

D3502

DELTA

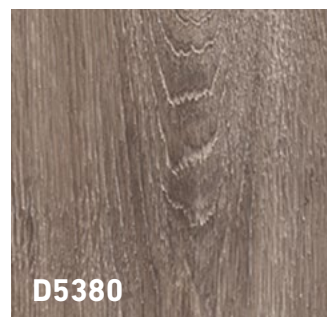

D5380

SIGMA

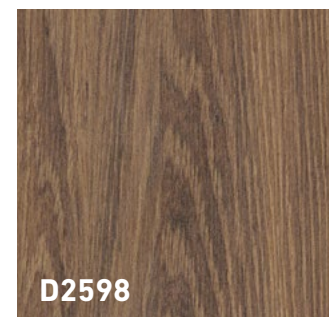

D2598

KAPPA

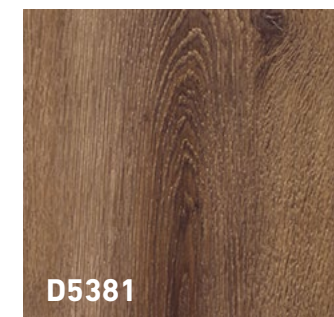

D5381

SIGMA

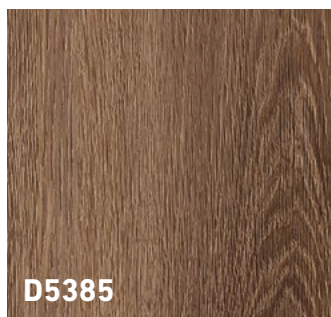

D5385

KAPPA

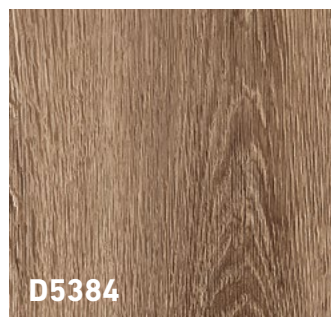

D5384

SIGMA

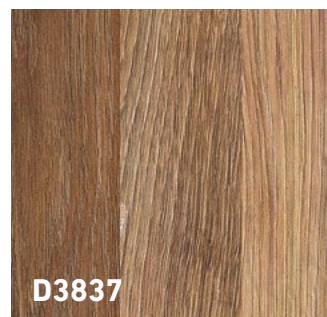

D3837

OMEGA

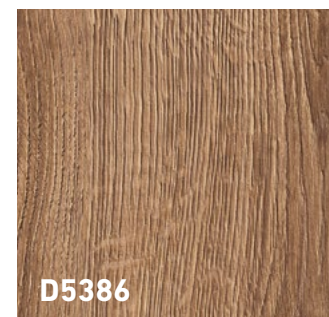

D5386

DELTA

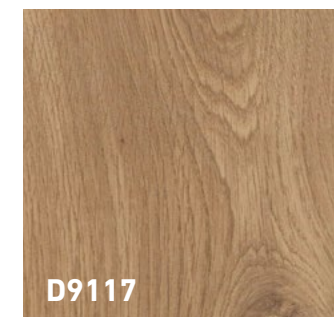

D9117

DELTA



D2019

OMEGA

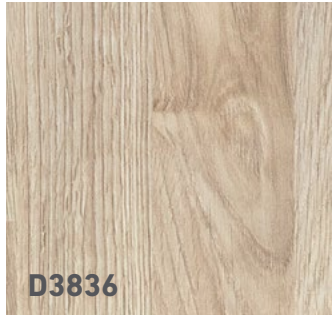

D3836

OMEGA

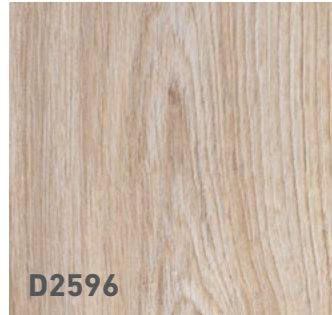

D2596

KAPPA



D5379

SIGMA



D5375

SIGMA



D5376

KAPPA

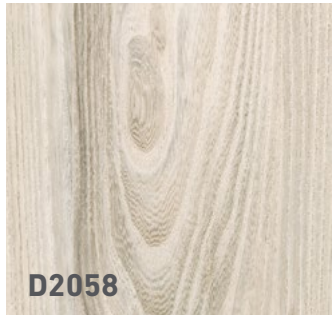

D2058

ALFA



D2022

ALFA

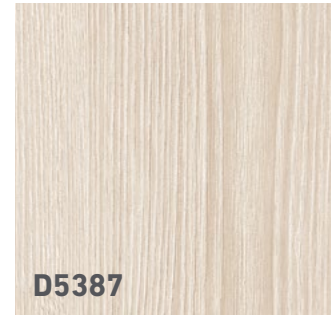

D5387

DELTA



D5383

KAPPA

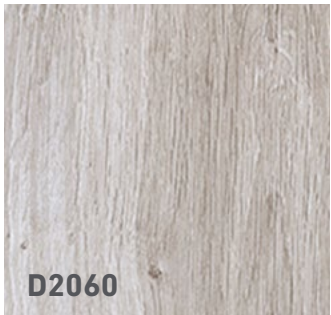

D2060

OMEGA



D3512

ALFA



D3461

DELTA



D5377

OMEGA

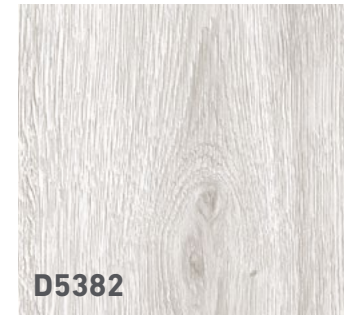

D5382

SIGMA

WŁAŚCIWOŚCI PROPERTIES СВОЙСТВА	Test Standard	ALFA	DELTA	OMEGA	KAPPA	SIGMA
STRUKTURA SURFACE СТРУКТУРА	—	WS	WG	SE	WG	WS
KRAWĘDZIE EDGES КРАЯ	—	PROSTA KRAWĘDŹ STRAIGHT EDGE ПРЯМОЙ КРАЙ	PROSTA KRAWĘDŹ STRAIGHT EDGE ПРЯМОЙ КРАЙ	PROSTA KRAWĘDŹ STRAIGHT EDGE ПРЯМОЙ КРАЙ	PROSTA KRAWĘDŹ STRAIGHT EDGE ПРЯМОЙ КРАЙ	V-FUGA V-GROOVE V-ФАСКА
OGRZEWANIE PODŁOGOWE FLOOR HEATING ОБОГРЕВ ПОЛА	—	✓	✓	✓	✓	✓
KLASYFIKACJA CLASSIFICATION КЛАССИФИКАЦИЯ	EN 13329	Class 23,32	Class 23,31	Class 23,32	Class 23,32	Class 23,32
Odporność na ścieranie Abrasion resistance Устойчивость к стиранию	EN 13329	AC4 ≥ 4000	AC3 ≥ 2000	AC4 ≥ 4000	AC4 ≥ 4000	AC4 ≥ 4000
Odporność na uderzenia Impact resistance Устойчивость к ударам	EN 13329	IC 2	IC 1	IC 2	IC 2	IC 2
Klasyfikacja ogniowa Fire classification Пожарная классификация	EN 13501-1	Cfl-s1	Cfl-s1	Cfl-s1	Cfl-s1	Cfl-s1
Opór cieplny Thermal resistance Тепловое сопротивление	EN 12667	7 mm: R < 0,057 (m2 K)/W	8 mm: R < 0,066 (m2 K)/W	8 mm: R < 0,066 (m2 K)/W	8 mm: R < 0,066 (m2 K)/W	8 mm: R < 0,066 (m2 K)/W
Odporność na poślizg Slip resistance Сопротивление к скольжению	EN 13893	DS	DS	DS	DS	DS
Emisja formaldehydu Formaldehyde emission Эмиссия формальдегида	EN 14041	E1	E1	E1	E1	E1

WŁAŚCIWOŚCI PROPERTIES СВОЙСТВА	Test Standard	ALFA	DELTA	OMEGA	KAPPA	SIGMA
Długość Length (l) Длина	EN 13329	1380 +/- 0,5mm	1380 +/- 0,5mm	1380 +/- 0,5mm	1380 +/- 0,5mm	1380 +/- 0,5mm
Szerokość Width Ширина	EN 13329	193 +/- 0,10mm	193 +/- 0,10mm	193 +/- 0,10mm	193 +/- 0,10mm	193 +/- 0,10mm
Grubość Thickness Толщина	EN 13329	7 +/- 0,5mm	8 +/- 0,5mm	8 +/- 0,5mm	8 +/- 0,5mm	8 +/- 0,5mm
Prostokątność elementu Squareness of the element Прямоугольность элемента	EN 13329	max≤0,20mm	max≤0,20mm	max≤0,20mm	max≤0,20mm	max≤0,20mm
Prostoliniowość krawędzi Edge straightness Прямолинейность краев	EN 13329	max ≤0,30mm	max ≤0,30mm	max ≤0,30mm	max ≤0,30mm	max ≤0,30mm
Płaskość elementu Flatness (f) Плоскость элемента	EN 13329	f(w)concave <0,15% f(w)convex <0,20% f(l)concave <0,50% f(l)convex <1,00%	f(w)concave <0,15% f(w)convex <0,20% f(l)concave <0,50% f(l)convex <1,00%	f(w)concave <0,15% f(w)convex <0,20% f(l)concave <0,50% f(l)convex <1,00%	f(w)concave <0,15% f(w)convex <0,20% f(l)concave <0,50% f(l)convex <1,00%	f(w)concave <0,15% f(w)convex <0,20% f(l)concave <0,50% f(l)convex <1,00%
Różnice wysokości pomiędzy elementami Height differences between elements (h) Разница в высоте между элементами	EN 13329	h _{aver.} ≤0,10 mm h _{max.} ≤0,15 mm	h _{aver.} ≤0,10 mm h _{max.} ≤0,15 mm	h _{aver.} ≤0,10 mm h _{max.} ≤0,15 mm	h _{aver.} ≤0,10mm h _{max.} ≤0,15mm	h _{aver.} ≤0,10 mm h _{max.} ≤0,15 mm
Szczeliny pomiędzy elementami Openings between elements (o) Щели между элементами	EN 13329	o _{aver.} ≤0,15 mm o _{max.} ≤0,20 mm	o _{aver.} ≤0,15 mm o _{max.} ≤0,20 mm	o _{aver.} ≤0,15 mm o _{max.} ≤0,20 mm	o _{aver.} ≤0,15 mm o _{max.} ≤0,20 mm	o _{aver.} ≤0,15 mm o _{max.} ≤0,20 mm
Przyrost grubości po pęcznieniu Thickness swelling Набухание по толщине	EN 13329	≤16%	≤16%	≤16%	≤16%	≤16%
Odporność na zaplamienia Resistance to staining Устойчивость к пятнам	EN 13329	5 (grupy/groups 1 and 2) 4 (grupa/group 3)	5 (grupy/groups 1 and 2) 4 (grupa/group 3)	5 (grupy/groups 1 and 2) 4 (grupa/group 3)	5 (grupy/groups 1 and 2) 4 (grupa/group 3)	5 (grupy/groups 1 and 2) 4 (grupa/group 3)



Grubość panelu
Panel thickness
Толщина панели



Struktura drewna szczotkowanego
Brushed wood structure
Структура с эффектом потёртости щёткой



Głęboka struktura drewna
Deep wood structure
Глубокая структура дерева



Struktura satynowy efekt
Satin effect structure
Структура с сатиновым эффектом



V-fuga na 4 krawędziach panela
4 sides v-groove
4-сторонняя фаска



Klasa ścieralności AC3
Abrasion Class AC3
Класс истираемости AC3



Klasa ścieralności AC4
Abrasion Class AC4
Класс истираемости AC4



Gwarancja 5 lat ścieralności w użytkowaniu publicznym
Warranty 5 years for abrasion – commercial use
Гарантия 5 лет на истираемость в коммерческих помещениях



Gwarancja 10 lat ścieralności w użytkowaniu mieszkalnym
Warranty 10 years for abrasion – residential use
Гарантия 10 лет на истираемость в жилых помещениях



Gwarancja 15 lat ścieralności w użytkowaniu mieszkalnym
Warranty 15 years for abrasion – residential use
Гарантия 15 лет на истираемость в жилых помещениях



Klasa użyteczności 31
Utility class 31
Класс износостойкости 31



Klasa użyteczności 32
Utility class 32
Класс износостойкости 32



Przystosowanie do ogrzewania podłogowego
Suitable for floor heating
Приспосблены к обогреваемым полам



Ilość paneli w 1 opakowaniu
No of panels in one box
Количество панелей в одной упаковке

INSTRUKCJA MONTAŻU
 INSTALLATION
 МОНТАЖ

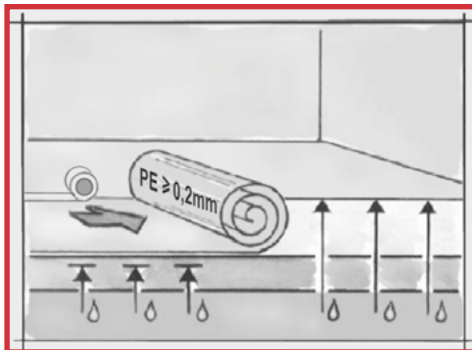

1.

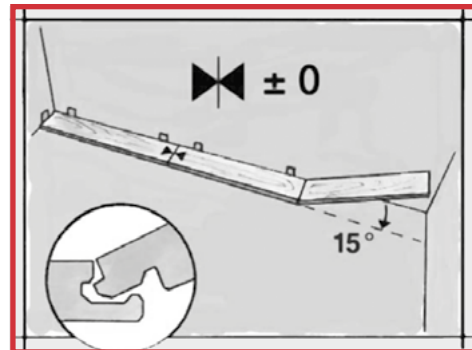

2.

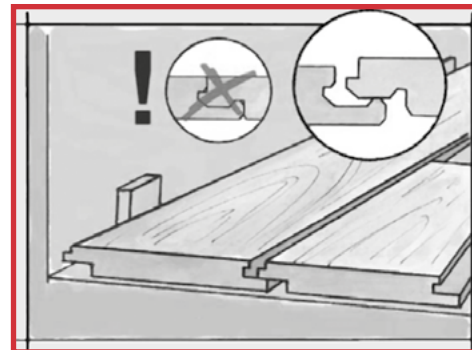

3.

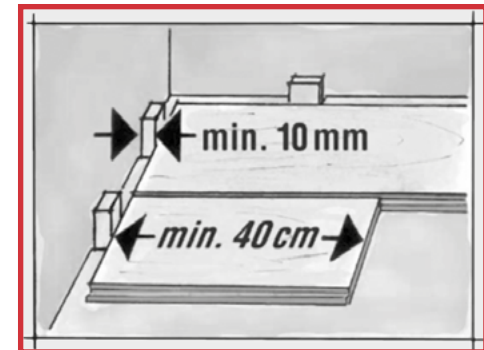

4.

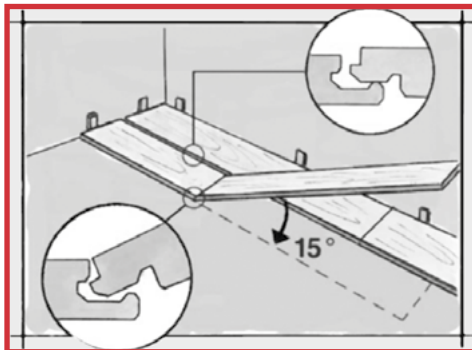

5.

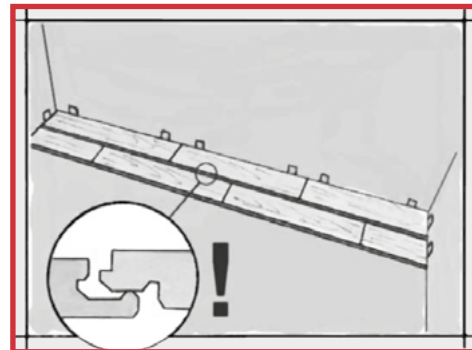

6.

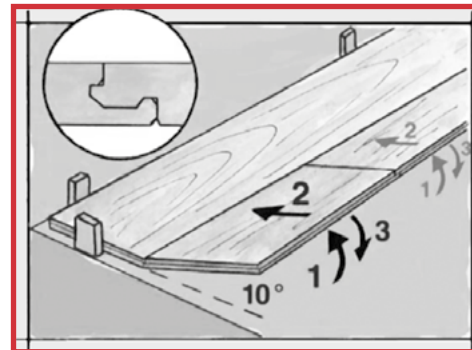

7.

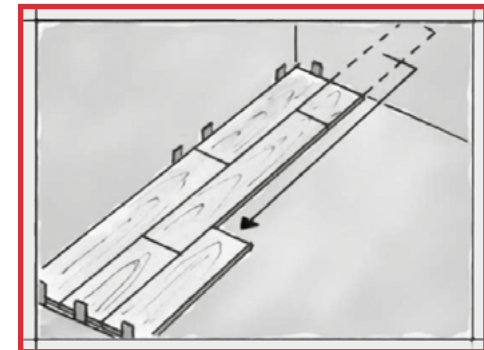

8.

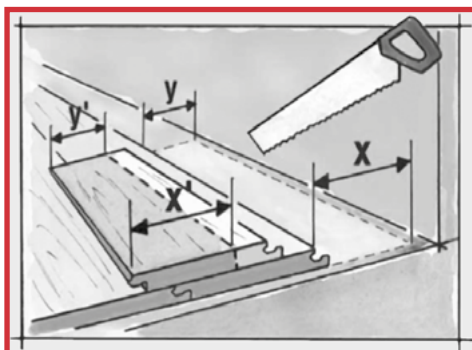

9.

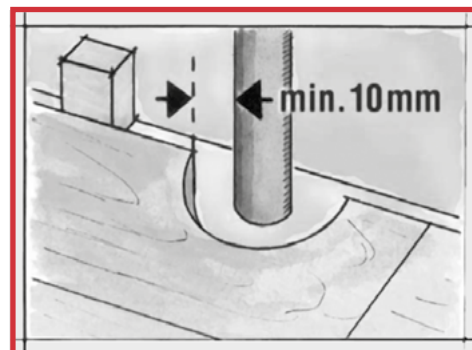

10.

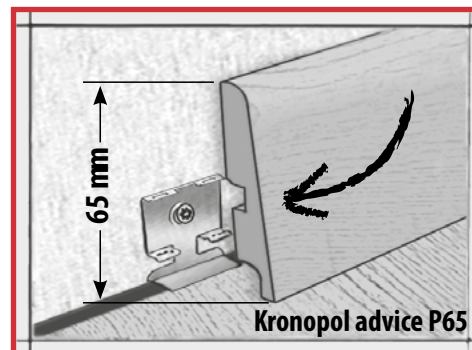

11.

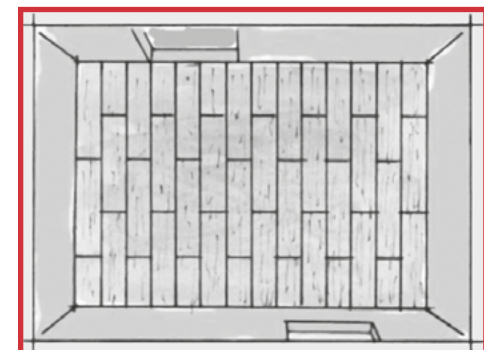

12.

Chwila relaksu

5 linii, 30 dekorów, setki inspiracji...

**Mamy nadzieję, że nowa linia podłóg
Kronopol FERRUM FLOORS przypadła Ci
do gustu!**

Ale, czy aby na pewno to już wszystko?

Na zdjęciach prezentowanych wewnątrz ukryliśmy 10 pamiątek z wakacji. Kreteńska amfora, muszla z Morza Śródziemnego czy zdjęcie z górskiej wycieczki. Nie łatwo znaleźć je wszystkie, ale jeśli Ci się uda, napisz do nas, podając listę znalezionych pamiątek i swój adres.

Na tropicieli wakacyjnych wspomnień, którym uda się odnaleźć wszystkie 10 ukrytych skarbów, czekają gadzety Swiss Krono!

marketing@kronopol.pl





Produkcowane zgodnie z wymaganiami normy PN-EN 13329. Przedstawiona kolorystyka ma wyłącznie charakter poglądowy i nie powinna być traktowana jako oryginalna. | Laminate Flooring is produced according to EN 13329. All colors shown in this publication are only sample colors and should not be considered as original ones. | Данная цветовая гамма является только наглядным материалом и не следует ее использовать в качестве оригиналов.

SWISS KRONO
ul. Serbska 56
68-200 Żary
Polska / Poland

Tel. +48 68 36 31 100
info@kronopol.pl

Menedżer Produktu tel. +48 68 36 31 297

www.swisskrono.pl